

# [High Precision] XY-Axis Linear Ball Slide

## Opposed Clamp with Knob

**Features:** Side mounted micrometer shaft is opposed by a knobbed screw to improve vibration resistance and secures greater locking power.

### XY-Axis, Opposed Clamp with Knob

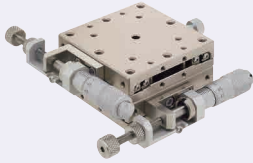

X-Axis: P.1924

RoHS10

#### Mounting Hole Dimensions of the Top Table

#### A25

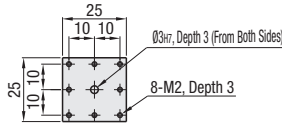

#### A60

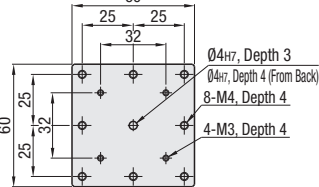

### XYSGNT

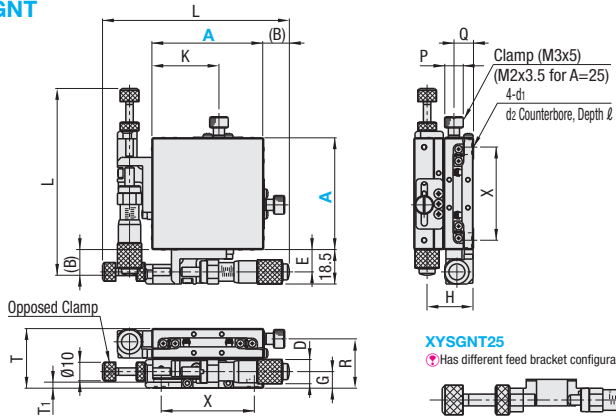

Type	Main Body		Ball		Spring	Micrometer Head Bracket		Tip Holder
	Material	Surface Treatment	Material	Hardness	Material	Material	Surface Treatment	Material
XYSGNT	SUS440C	Electroless Nickel Plating	SUS440C	58HRC~	SUS304WPB	A5052	Clear Anodize	SUS303
						SUS303*	-	

\* Bracket material will be different for 25 square only.

For micrometer head and opposed clamp materials, see Adjust Screws ANKSS on P.1712.

Opposed clamp shaft has a hex socket (2.5 hex, depth 2.5) on the end.

#### A40

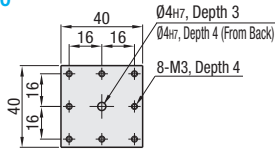

#### A50

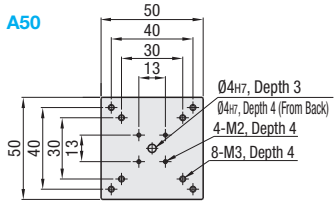

#### A70

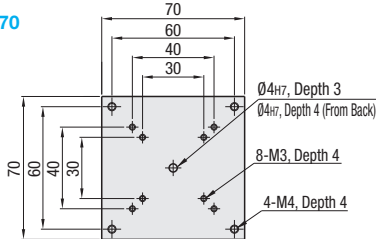

Part Number	Top View				Front View							Side View					Accessory (4 pcs.)						
	Type	A	(B)	E	K	L	D	G	T	T <sub>1</sub>	R	H	P	Q	X	d <sub>1</sub>		d <sub>2</sub>	ℓ	Type M-L			
XYSGNT	25	30	7	15	84.5	9.3	6.7	24	3.7	20.5	18.7	6	8.5	20	2.5	4.2	2.5	SCB2-4					
	40	23.8	12	26	100.3	13	8.9	32	4.5	26.5	24.9	10	10.5	32	3.5	6	3.5	SCB3-6					
	50	18.8		31										40									
	60	13.8	36	50										4									
	70	14.3	46.5	10											36	6	29.5		28	11.5	60	4.5	8

#### Performance

Part Number	Stage Surface (mm)	Travel Distance (mm)	Horizontal Load Capacity (N)	Travel Accuracy				Moment Load Capacity (N · m)			Moment Rigidity (N / cm)			Parallelism	Orthogonality	Weight (kg)	Unit Price
				Straightness	Parallelism	Pitching	Yawing	Pitching	Yawing	Rolling	Pitching	Yawing	Rolling				
XYSGNT	25	25x25	±3.2	38.2	3μm	10μm	30"	25"	2.0	2.0	3.5	3.0	2.2	2.2	30μm	10μm	0.14
	40	40x40	±6.5	95.1	1μm	12μm	25"	15"	5.0	5.0	5.0	0.63	0.70	0.63			0.46
	50	50x50		144.1					6.0	6.8	6.0	0.24	0.28	0.24			0.56
	60	60x60		192.1					9.0	10.0	9.0	0.13	0.16	0.13			0.8
	70	70x70		219.5					12.9	13.8	12.9	0.09	0.10	0.90			1.16

Micrometer Head Resolution: 10μm/division

Knob Cover HDCVR13 (Sold Separately): Ø13 micrometer head or feed screw knob can be increased in diameter to Ø30 by installing the cover. P.2004

Extension Cover HDEXT13 (Sold Separately): Knob of Ø13 micrometer head and feed screw can be extended. P.2004

For orders larger than indicated quantity, please request a quotation.



Ordering Example

Part Number  
XYSGNT60