

## ■ Accessories (Order Separately)

### Watertight Cover

Y92A-96N

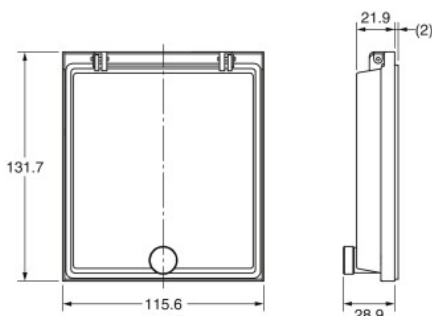

### Panel Cutout

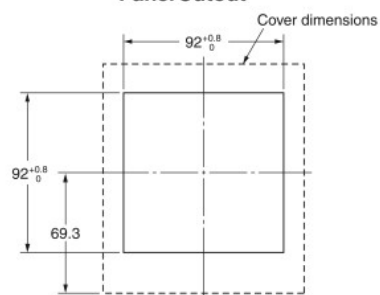

Use for flush mounting when waterproofing is required. The Y96A-96N conforms to IP66 and NEMA4 (for indoor use) standards for waterproofing. The operating environment may cause the waterproof packing to deteriorate, shrink, or harden. Therefore, it is recommended that the packing be replaced regularly.

### Protective Cover

Y92A-96B



A hardened Y92A-96B Protective Cover is available. Use it for the following:

- To protect the front panel from dust and dirt.
- To prevent the set value from being altered due to accidental contact with the keys or switches.

### DIN Track Mounting Base

Y92F-91

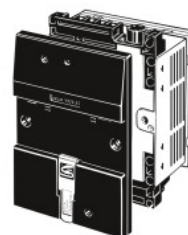

### Discrete Wire Output Cable

Y92S-41-200

Cable length: 2 m

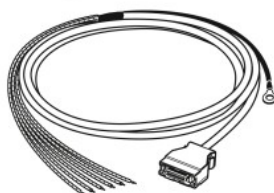

### Connector-type Output Cable

E5ZE-CBL200

Cable length: 2 m



### Mounting Track

PFP-100N  
PFP-50N

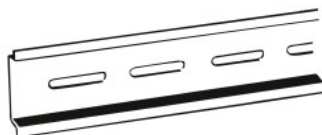

PFP-100N2

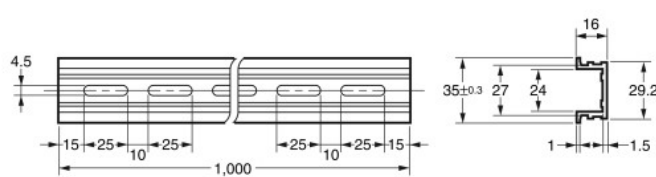
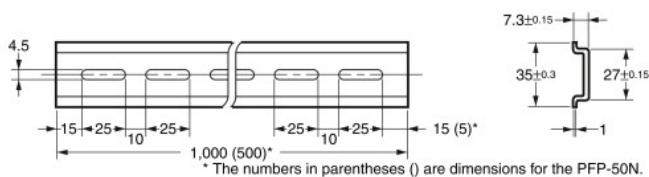

\* The numbers in parentheses ( ) are dimensions for the PFP-50N.

### End Plate

PFP-M

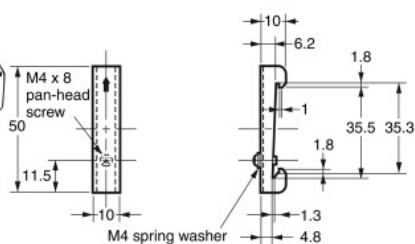

### Spacer

PFP-S

