

AE8

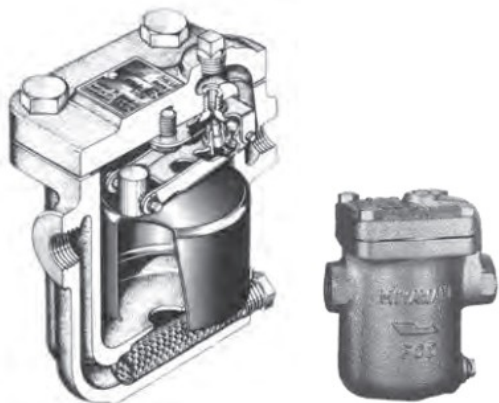

AV

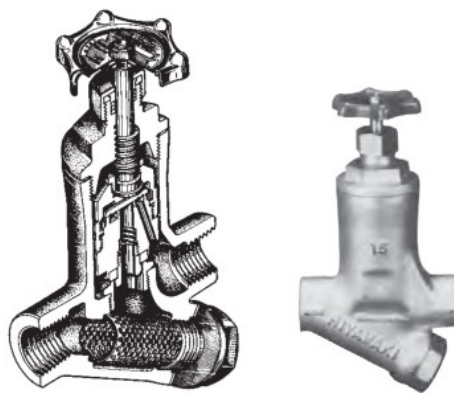

Capacity Chart AE8

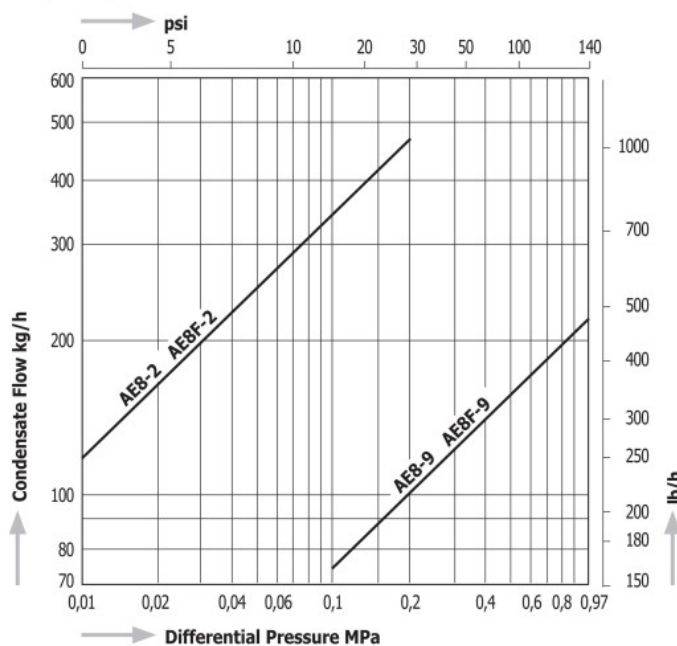

Capacity Chart AV

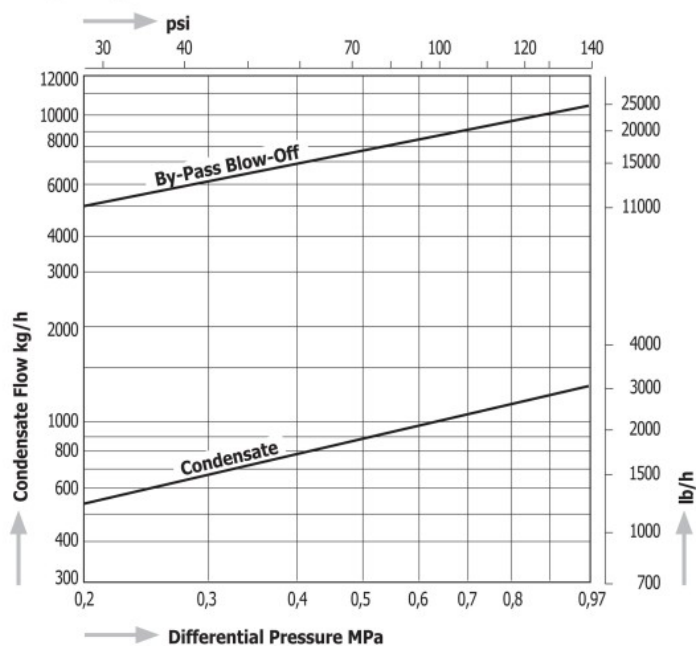

Dimensions

AE8

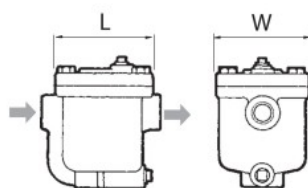

AE8F

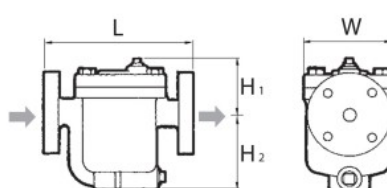

AV

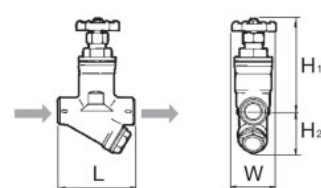

| Model | Connections | Size | Max. Operating Pressure | | Max. Operating Temperature | | Dimensions (mm) | | | | Dimensions (in) | | | | Body Material | Weight | |
|--------|------------------------|------|-------------------------|------|----------------------------|-----|-----------------|----------------|----------------|-----|-----------------|----------------|----------------|-----|--------------------------|--------|------|
| | | | MPa | psig | °C | °F | L | H ₁ | H ₂ | W | L | H ₁ | H ₂ | W | | kg | lb |
| AE8-2 | Screwed Rc, NPT | 1/2" | 0,2 | 29 | 350 | 662 | 130 | 73 | 90 | 100 | 5.1 | 2.9 | 3.5 | 3.9 | Ductile Cast Iron FCD450 | 3,7 | 8.1 |
| | | 3/4" | | | | | 135 | 73 | 90 | 100 | 5.3 | 2.9 | 3.5 | 3.9 | | 3,9 | 8.6 |
| | | 1" | | | | | 130 | 73 | 90 | 100 | 5.1 | 2.9 | 3.5 | 3.9 | | 3,7 | 8.1 |
| | | 1/2" | | | | | 135 | 73 | 90 | 100 | 5.3 | 2.9 | 3.5 | 3.9 | | 3,9 | 8.6 |
| AE8F-2 | Flanged JIS, ASME, DIN | 1/2" | 0,2 | 29 | 350 | 662 | 175 | 73 | 90 | 100 | 6.9 | 2.9 | 3.5 | 3.9 | Ductile Cast Iron FCD450 | 5,3 | 11.7 |
| | | 3/4" | | | | | 195 | 68 | 95 | 100 | 7.7 | 2.7 | 3.7 | 3.9 | | 5,7 | 12.5 |
| | | 1" | | | | | 215 | 73 | 90 | 100 | 8.5 | 2.9 | 3.5 | 3.9 | | 6,8 | 15.0 |
| | | 1/2" | | | | | 195 | 73 | 90 | 100 | 6.9 | 2.9 | 3.5 | 3.9 | | 5,3 | 11.7 |
| AE8F-9 | Screwed Rc, NPT | 3/4" | 0,97 | 140 | 150 | 302 | 195 | 68 | 95 | 100 | 7.7 | 2.7 | 3.7 | 3.9 | Cast Iron FC250 | 5,7 | 12.5 |
| | | 1" | | | | | 215 | 73 | 90 | 100 | 8.5 | 2.9 | 3.5 | 3.9 | | 6,8 | 15.0 |
| | | 1/2" | | | | | 120 | 155 | 60 | 65 | 4.3 | 6.1 | 2.4 | 2.6 | | 2,4 | 5.3 |
| AV-4 | Screwed Rc, NPT | 3/4" | 0,97 | 140 | 150 | 302 | 120 | 155 | 65 | 65 | 4.7 | 6.1 | 2.6 | 2.6 | Cast Iron FC250 | 2,5 | 5.5 |
| AV-6 | | 1" | | | | | 120 | 155 | 70 | 70 | 4.7 | 6.1 | 2.8 | 2.6 | | 2,7 | 6.0 |
| AV-8 | | 1" | | | | | 120 | 155 | 70 | 70 | 4.7 | 6.1 | 2.8 | 2.6 | | 2,7 | 6.0 |