

軽量・スリム・長ストローク

Light, slim, long stroke

X 軸 X-axis

XLSR-100

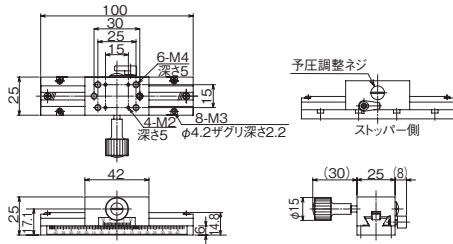
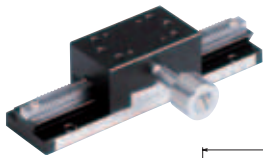

取付寸法図

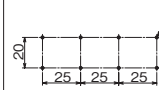

表面からの取付
M2ねじを使用して
製品の上側より取付

裏面からの取付
M3ねじを使用して
製品の下側より取付

Surface mounting
M2 products using the mounting
screws of the upper

Backside mounting
M3 product from the bottom of
the mounting screws

XLSR-150

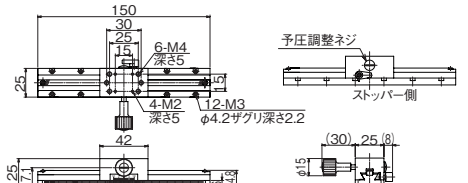
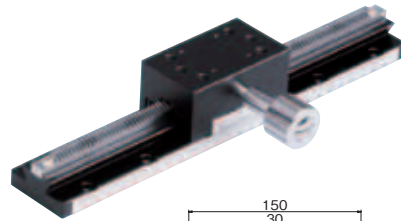

取付寸法図

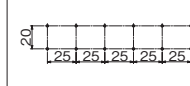

表面からの取付
M2ねじを使用して
製品の上側より取付

裏面からの取付
M3ねじを使用して
製品の下側より取付

Surface mounting
M2 products using the mounting
screws of the upper

Backside mounting
M3 product from the bottom of
the mounting screws

支柱ホルダー式 Support holder type

XLSR-100BC

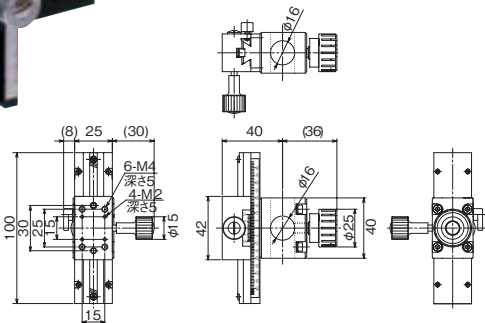

XLSR-150BC

